

## T8011R Programmable Heat Pump Thermostat

### INSTALLATION INSTRUCTIONS

#### APPLICATION

The T8011R Heat Pump Thermostat provides 24 Vac control of a two-stage heating and one-stage cooling heat pump system with manual changeover from heat to cool. First stage heating and cooling cycle rates are fixed at 3 cph. Second stage heating cycle rate is selectable at 3, 4, 5, 6, 9 or 12 cph. Temperature indication can be set for °F or °C.

The T8011R Heat Pump Thermostat is powered directly from the system transformer. Setpoints are held permanently in memory and retained during power outages.

The T8011R TRADELINE® model includes a thermostat, wallplate and owner's guide. A 7 3/8 in. (188 mm) x 5 3/4 in. (146 mm) decorator cover plate (for covering wall marks) is available separately. Order Honeywell part no. 209649A (taupe) or part no. 209649B (white).



#### MERCURY NOTICE

If this control is replacing a control that contains mercury in a sealed tube, do not place your old control in the trash. Dispose of it properly.

Contact your local waste management authority for instructions regarding recycling and the proper disposal of a control.

#### INSTALLATION

##### When Installing this Product...

1. Read these instructions carefully. Failure to follow them could damage the product or cause a hazardous condition.
2. Check the ratings given in the instructions and on the product to make sure the product is suitable for your application.

3. Installer must be a trained, experienced service technician.
4. After installation is complete, check out product operation as provided in these instructions.



#### CAUTION

**Hazardous Voltage  
Can damage heating/cooling system.**  
Disconnect power at furnace or main breaker/fuse box.

#### Location

Install the thermostat about 5 ft (1.5m) above the floor in an area with good air circulation at average temperature. See Fig. 1. Do not install the thermostat where it can be affected by:

- drafts or dead spots behind doors and in corners.
- hot or cold air from ducts.
- radiant heat from the sun or appliances.
- concealed pipes and chimneys.
- unheated (uncooled) areas such as an outside wall behind the thermostat.

#### Mounting Wallplate to Wall

##### IMPORTANT

Level for appearance only. The thermostat functions normally even when not level.

Mount wallplate and the T8011R with the screws provided (see Fig. 2) as follows:

1. Place the wallplate at the desired location on the wall.
2. Pull the thermostat wire through the wallplate entrance hole.
3. Fasten the wallplate to the wall using the anchors and screws provided.
4. After wiring the wallplate, plug the hole with non-flammable insulation to prevent drafts from affecting the thermostat; see Wiring section.

Table 1. Description of T8011R Thermostats.

Model	System	Changeover	System Selection	Fan Selection	Powering Method
T8011R	Heat Pump	Manual	Cool-Off-Heat-Em. Ht.	Auto-On	Hardwired



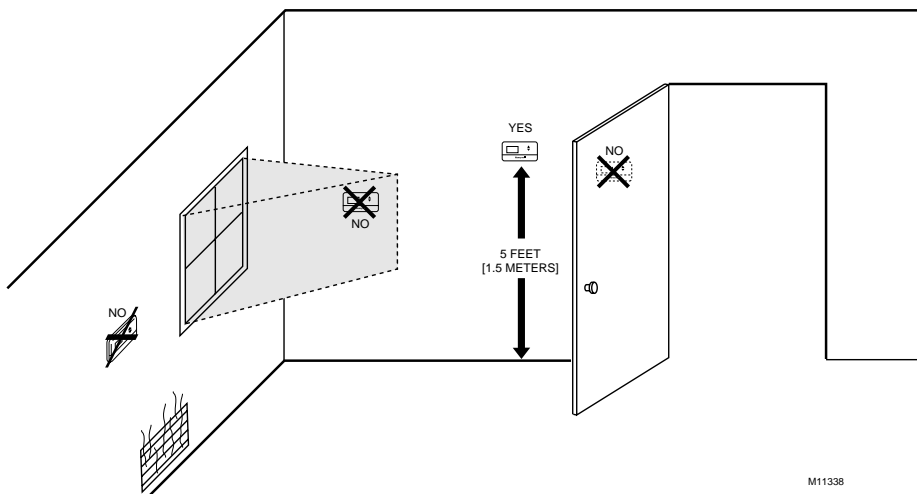

M11338

Fig. 1. Typical location of thermostat.

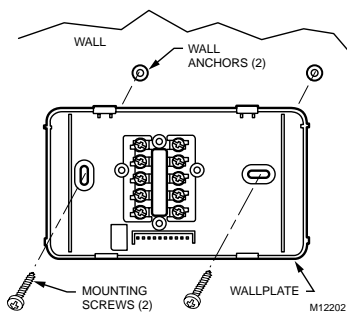

Fig. 2. Mounting wallplate to wall.

## Wiring

### IMPORTANT

Use 18-gauge maximum wire for wiring the T8011R Thermostat.

All wiring must comply with local electrical codes and ordinances. Disconnect the power supply to prevent electrical shock or equipment damage.

The shape of the terminals permits insertion of straight or wraparound wiring connections; either method is acceptable. A letter code is located near each terminal for identification. See Fig. 3.

NOTE: To ensure proper mounting of thermostat, restrict all wiring to the shaded area in the center of the terminals. See Fig. 4.

Refer to Fig. 5 for typical wiring hookup.

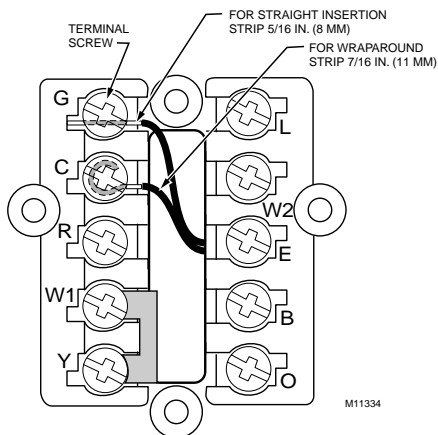

Fig. 3. Wiring connections.

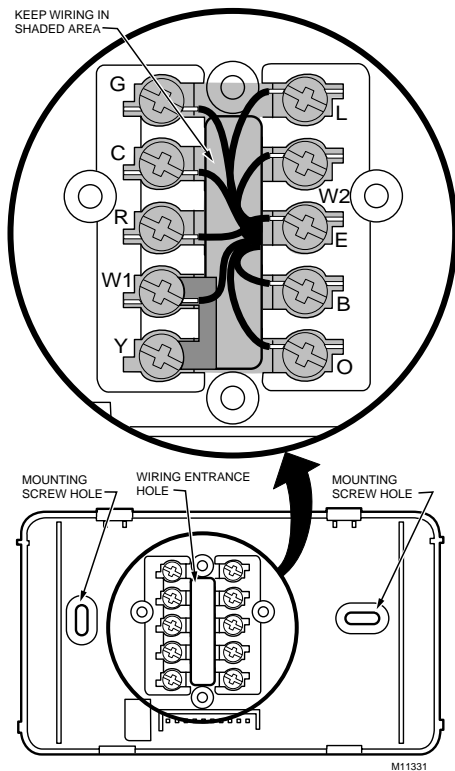

Fig. 4. Restrict wiring to shaded area.

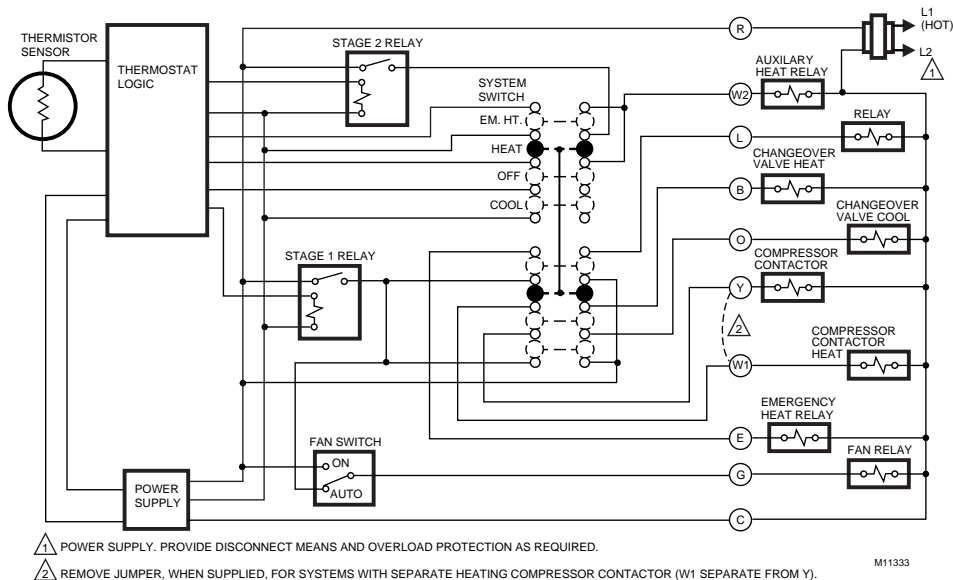
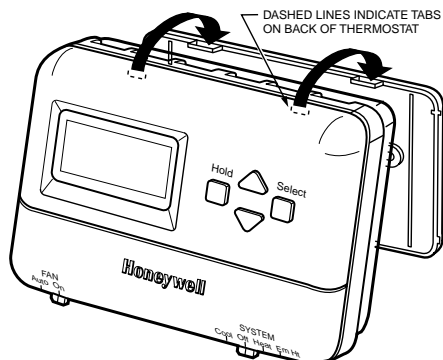

Fig. 5. T8011R two stage heat, one stage cool wiring diagram with manual changeover.

## Mounting Thermostat To Wallplate

1. Slide SYSTEM switch to the Off position.
2. Engage the tabs at the top of the thermostat and wallplate.
3. Swing down the thermostat and press the lower edge of the thermostat onto the wallplate to latch. See Fig. 6.



**A** ENGAGE TABS AT TOP OF THERMOSTAT WITH SLOTS ON MOUNTING PLATE.

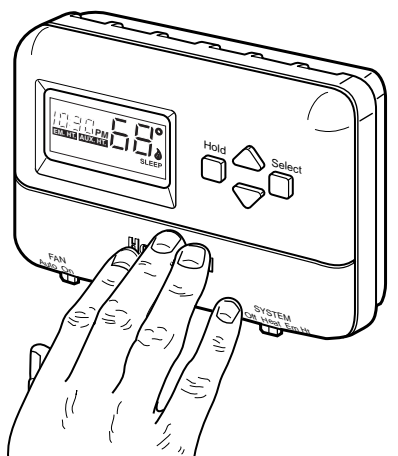

**B** PRESS LOWER EDGE OF CASE TO LATCH.

Fig. 6. Mounting thermostat to wallplate.

## INSTALLER SETUP

### Setting °F/°C Indication and Heat Cycle Rate

The following instructions provide the information necessary to change the heating cycle rate to match the heating equipment and to choose either Fahrenheit (°F) or Celsius (°C) display.

NOTE: All four steps must be completed to save changes to the °F/°C indication and the heat cycle rate.

1. Enter Installer Setup.
  - a. Use ▲ or ▼ keys to set the temperature setpoint to 52 °F (11°C).
  - b. Press the ▲ and ▼ keys simultaneously for more than two seconds to enter installer setup.
  - c. When released the three-digit software revision code displayed.
  - d. Press the ▲ key. Factory configuration (FC) is displayed (A typical example is shown, but information displayed varies by model. This information is for factory use only).

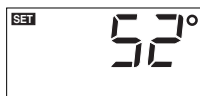

M12582A

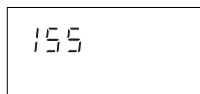

M12583A

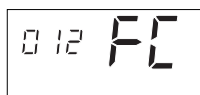

M12584A

### Optional System Checkout

When in steps 1c and 1d only, pressing the ▼ key can be used to turn heat or cool outputs on and off. Change the SYSTEM switch setting to test heat or cool outputs. During testing, the 5 minute minimum off time is bypassed. No action takes place if the system switch is in the Off position.

Examples: System setting at HEAT: If heat is on, pressing the ▼ key turns it off; if heat is off, pressing the ▼ key turns it on.

System setting at COOL: If cool is on, pressing the ▼ key turns it off; if cool is off, pressing the ▼ key turns it on.

NOTE: In installer setup only, each press of the ▲ key momentarily displays 1. Each press of the ▼ key momentarily displays 2. When the keys are released, these one-digit codes are no longer displayed.

2. Setting °C or °F.
  - a. Press the ▲ key again to display the current setting.
  - b. Press the ▼ key to change the °C or °F indication.



M12587A



M12586A

3. Setting Heat Cycle Rate (see Table 2 for cycle rate options and equipment).

a. Press the ▲ key to display the current heat cycle rate setting of 3, 4, 5, 6, 9 or 12 cph.



M12588A

b. If the desired cycle rate is displayed, press the ▲ key to exit the installer setup.



M12589A

c. To change the heat cycle rate, press the ▼ key until your choice of 3, 4, 5, 6, 9 or 12 is displayed.

d. Press the ▲ key to display cooling algorithm configuration default.

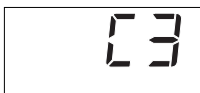

M14691

e. Press the ▲ key again to change cooling algorithm to C1 or C3.

C1 = Standard cooling algorithm.  
C3 = Aggressive cooling algorithm (can cause overshooting).

f. Press the ▲ key again. Current configuration (CC) is displayed. A typical example is shown, but CC varies by model. (This information is for factory use only.)

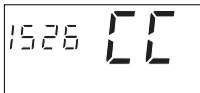

M14692

4. Exit Installer Setup.

a. Press the ▲ key to save all changes and return to normal operation.



M12590A

Table 2. Heating Cycle Rate

System	Cycles Per Hour
Hydronic Heat, Condensing Gas Furnaces <sup>a</sup>	3
Gas or Oil Forced Air	6
Electric Heat	9
Special Applications <sup>b</sup>	4, 5, 12

<sup>a</sup>High efficiency furnace (90+).

<sup>b</sup>Refer to the equipment manufacturer's Instructions.

NOTE: Stage one heat and cool cycle rates are fixed at 3 cph. Only stage two heat cycle rates are selectable.

## OPERATION

### Setting FAN and SYSTEM Switches

Fan and system settings are controlled manually by using the switches located at the bottom of the thermostat case. See Fig. 7.

#### FAN Switch

Fan switch settings are:

On: The fan runs continuously. Use for improved air circulation and air quality.

Auto: Normal setting for most homes. The fan starts and stops with the equipment.

Slide the FAN switch in the lower left corner of the thermostat to select the desired fan setting.

#### SYSTEM Switch

System switch settings control thermostat operation as follows:

Cool: The thermostat controls the cooling system.

Off: Both heating and cooling are off.

Heat: The thermostat controls the heating system.

Em. Ht.: The thermostat cycles auxiliary heat (W2) and emergency heat relay (E) as needed to maintain setpoint. Terminal L is energized continuously (fault heat relay is on continuously). Cooling system is off. Compressor is de-energized.

Slide the SYSTEM switch in the lower right corner of the thermostat to select the desired system setting.

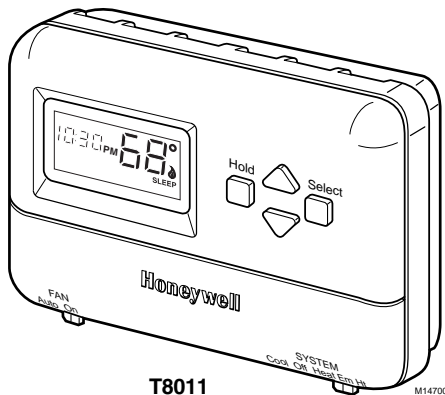

T8011

M14700

Fig. 7. Digital Display and System Switches.

## Setting Current Time and Day

1. To Set Current Time.
  - a. Press Select twice.

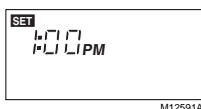

- b. Press ▲ or ▼ to set current time.

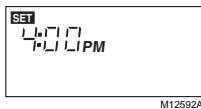

2. To Set Day of Week.

- a. Press Select again.

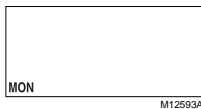

- b. Press ▲ or ▼ to set current day.

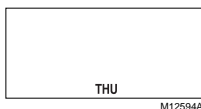

To use the preprogrammed time and temperature press Hold to exit the programming mode.

## Setting Time And Temperature

The T8000C is preprogrammed with the time and temperature settings shown in Table 3. For instructions on programming the thermostat refer to the Owners Guide, Form No. 69-1143.

**Table 3. Preprogrammed Time and Temperature Settings.**

Period	Time	Heat Setpoint	Cool Setpoint
Wake	6:00 AM	70°F (21°C)	78°F (26°C)
Leave	8:00 AM	62°F (17°C)	85°F (29°C)
Return	6:00 PM	70°F (21°C)	78°F (27°C)
Sleep	10:00PM	62°F (17°C)	82°F (28°C)

## CHECKOUT



### CAUTION

**Damage To Compressor Possible. Operating at too low of an outdoor temperature may cause compressor damage.**

Do not operate cooling if outdoor temperature is below 50°F (10°C).

Allow compressor to remain off for five minutes before restarting.

Refer to manufacturer's recommendations.

## Heating

1. Slide the SYSTEM switch to Heat and the FAN switch to Auto.
2. Press and hold the ▲ key to raise the temperature setting several degrees above the room temperature; the heating equipment should start.
3. Press the ▼ key to lower the temperature setting below the room temperature. Heating equipment should stop.

## Cooling

1. Slide the SYSTEM switch to Cool and the FAN switch to Auto.
2. Press the ▼ key to lower the temperature setting several degrees below the room temperature; the cooling equipment and fan should start.

**NOTE:** If unit doesn't start immediately, remember, the thermostat has a built-in minimum off-time of five minutes to protect the compressor.

3. Press the ▲ key to raise the temperature setting above the room temperature. Cooling system should shut down.

## Fan

1. Slide the SYSTEM switch to Off and the FAN switch to On. The fan should run continuously.
2. Slide the FAN switch to Auto. The system turns the fan on or off with the equipment.

Make certain all equipment responds correctly to the thermostat.

**Honeywell**

### Automation and Control Solutions

Honeywell  
1985 Douglas Drive North  
Golden Valley, MN 55422

Honeywell Limited-Honeywell Limitée  
35 Dynamic Drive  
Scarborough, Ontario  
M1V 4Z9