

V5011N Two-Way Threaded Globe Valve

PRODUCT DATA

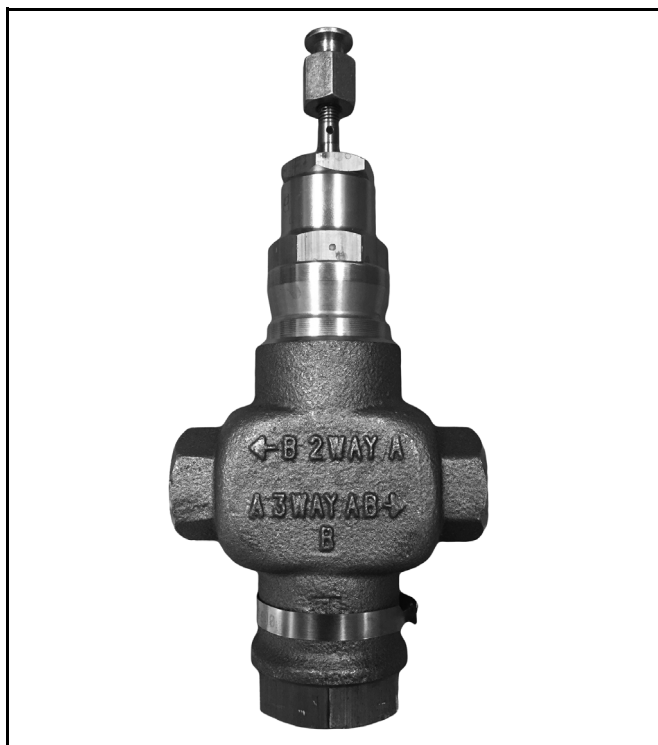

FEATURES

- Red brass body with NPT-threaded end connections.
- Low seat leakage rate (≤ 0.05 percent of C_v).
- 50:1 rangeability per VDI/VDE 2173.
- Spring-loaded, self-adjusting packing.
- Accurate positioning to ensure state of the art temperature control.
- Directly coupled electric and pneumatic actuators for easy mounting.
- Sizes range from 1/2 in. to 2 in.
- Valve designs provide equal percentage flow characteristic for water and linear flow characteristic for steam.
- Stainless steel stem and metal-to-metal seats.
- Repack and rebuild kits for field servicing.

APPLICATION

The V5011N is a two-way threaded globe valve that controls steam, water, and glycol solutions (up to 50 percent concentration) in heating or cooling HVAC applications. The valve is used in two-position and modulating control systems. The valve is not suitable for combustible gas service.

Contents

Application	1
Features	1
Specifications	2
Ordering Information	2
Installation	5
Checkout	7



SPECIFICATIONS

IMPORTANT

The specifications given in this publication do not include normal manufacturing tolerances. Therefore, an individual unit may not exactly match the listed specifications. Also, this product is tested and calibrated under closely controlled conditions and some minor differences in performance can be expected if those conditions are changed.

Models:

V5011N Valve: Two-way threaded globe valve for steam, water, or glycol. NPT-threaded pipe connections. Throttling plug provides equal percentage flow characteristic for water (V5011N1xxx, V5011N3xxx), linear flow characteristic for steam (V5011N2xxx).

NOTE: V5011N1xxx and V5011N2xxx are direct acting (stem down to close).
V5011N3xxx is reverse acting (stem up to close).

Dimensions: See Fig. 1.

Valve Sizes and Flow Capacities: See Table 1.

Pipe Connections: Internal NPT-threaded connections.

Seat: Stainless steel, replaceable (except V5011N3xxx 3/4 in. to 1-1/4 in. which have an integral brass seat).

ANSI Body Class: 150 psi.

Stem: Stainless steel.

Plug: Brass on V5011N1xxx and V5011N3xxx for water; stainless steel on V5011N2xxx for steam.

Stroke: 3/4 in. (20 mm).

Approximate Leakage Rate: 0.05 percent C_v .

Pattern: 2-way, straight-through.

Body Material: Red brass.

Packing: Spring-loaded, carbon fiber reinforced PTFE V-rings.

Rangeability: 50:1 per VDI/VDE 2173.

Pressure-Temperature Ratings:

Water: 36°F to 248°F, 217 psi (15 bar).
248°F to 337°F, 185 psi (12.8 bar).
Maximum Water Differential Pressure: 230 psid (15.8 bar).
Steam: 100 psi (6.9 bar) at 337°F (V5011N2xxx).

Maximum Differential for Quiet Water Service: 20 psid.

Valve Flow Characteristics:

Water: Equal percentage (V5011N1xxx, V5011N3xxx).
Steam: Linear (V5011N2xxx). See Fig. 2.

Close-Off Pressure Ratings: See Fig. 3, and Table 2.

Valve Design Life: 250,000 full cycles at maximum rated temperature.

Replacement Parts: See Fig. 5 and Table 3.

Motor and Linkage Selection:

Electric	Pneumatic
ML6421/ML6425	MP953C (5 and 8 in.)
ML7421/ML7425	MP953E (5 and 8 in.)
ML7984/ML6984	—
Modutrol IV with Q5001	—
Damper DCA with Q5020	—

Table 1. Valve Size and Flow Capacities.

Size (in.)	Capacity (C_v)
1/2	0.73
	1.16
	1.85
	2.9
	4.7
3/4	7.3
1	11.7
1-1/4	18.7
1-1/2	29.3
2	46.8

ORDERING INFORMATION

When purchasing replacement and modernization products from your TRADELINE® wholesaler or distributor, refer to the TRADELINE® Catalog or price sheets for complete ordering number. If you have additional questions, need further information, or would like to comment on our products or services, please write or phone:

1. Your local Honeywell Environmental and Combustion Controls Sales Office (check white pages of your phone directory).
2. Honeywell Customer Care
1985 Douglas Drive North
Golden Valley, Minnesota 55422-4386
3. <http://customer.honeywell.com> or <http://customer.honeywell.ca>

International Sales and Service Offices in all principal cities of the world. Manufacturing in Belgium, Canada, China, Czech Republic, Germany, Hungary, Italy, Mexico, Netherlands, United Kingdom, and United States.

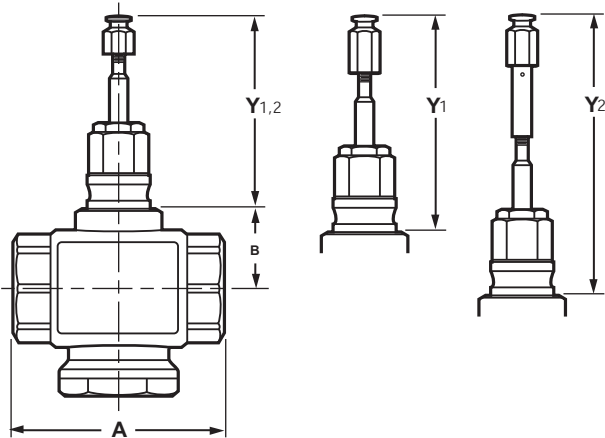

VALVE SIZE (IN)	A in. (mm)	B in. (mm)
1/2	3-1/4 (83)	1-9/16 (40)
3/4		
1	4-1/16 (103)	
1-1/4	4-3/16 (106)	
1-1/2	4-3/4 (120)	1-13/16 (47)
2	5-1/4 (134)	

VALVE	Y1 in. (mm)	Y2 ^a in. (mm)
V5011N1XXX OR V5011N2XXX	3-1/2 (89)	5-1/4 (133)
STEM FULLY DOWN		
V5011N3XXX	4-3/16 (107)	5-15/16 (151)
STEM FULLY UP		

^aY2 WITH STEM EXTENSION FOR MP953C,E (8 IN. ONLY) M17378A

Fig. 1. V5011N body dimensions in in. (mm).

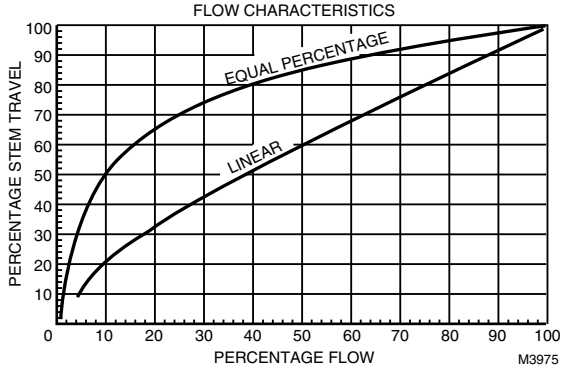
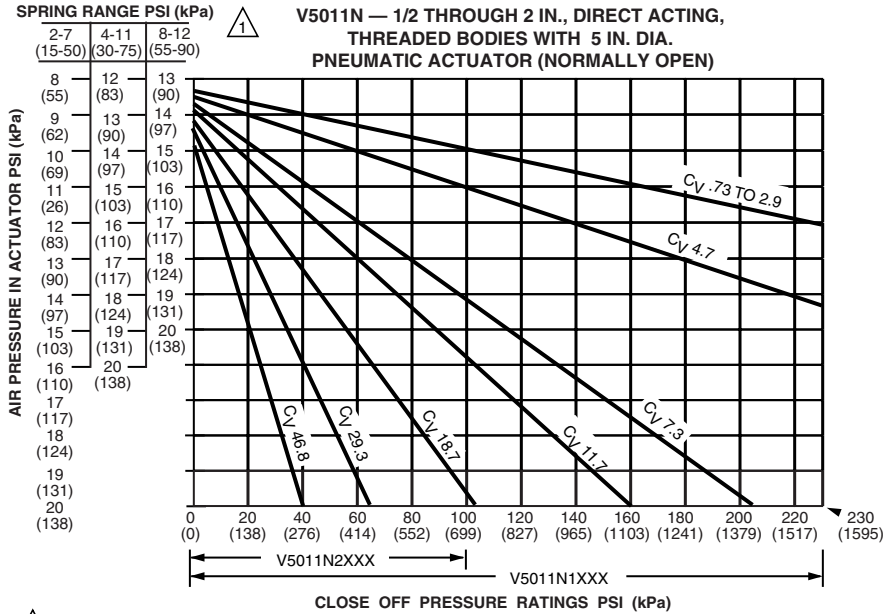

Fig. 2. Equal percentage and linear flow characteristics.



△ USE 4-11 PSI SPRING FOR POSITIONER MODEL (MP953E). M16049

Fig. 3. Close-off ratings at various control air pressures for V5011N Valves and MP953 Pneumatic Actuators.

V5011N TWO-WAY THREADED GLOBE VALVE

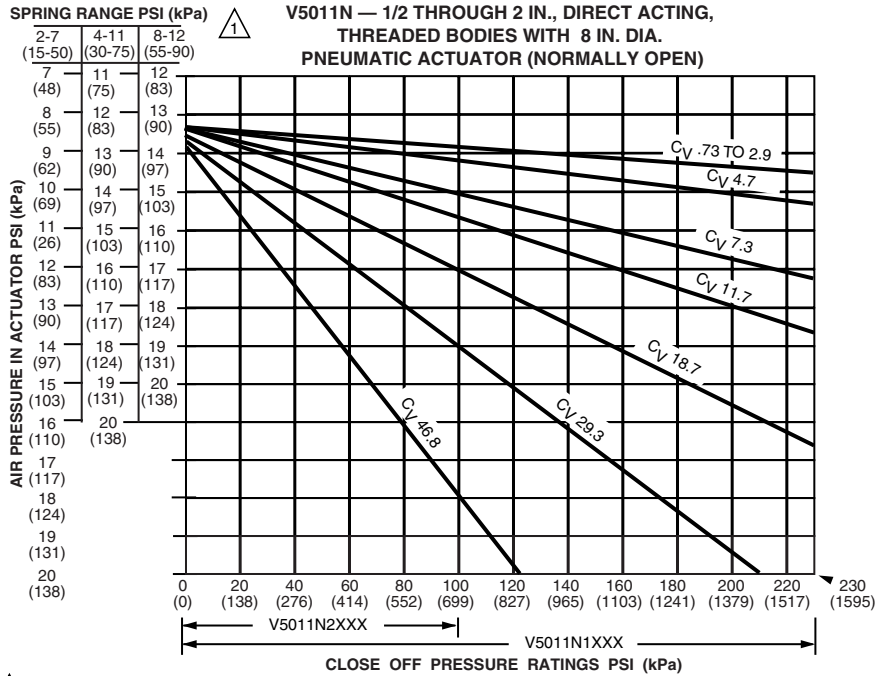

△ USE 4-11 PSI SPRING FOR POSITIONER MODEL (MP953E). M16050

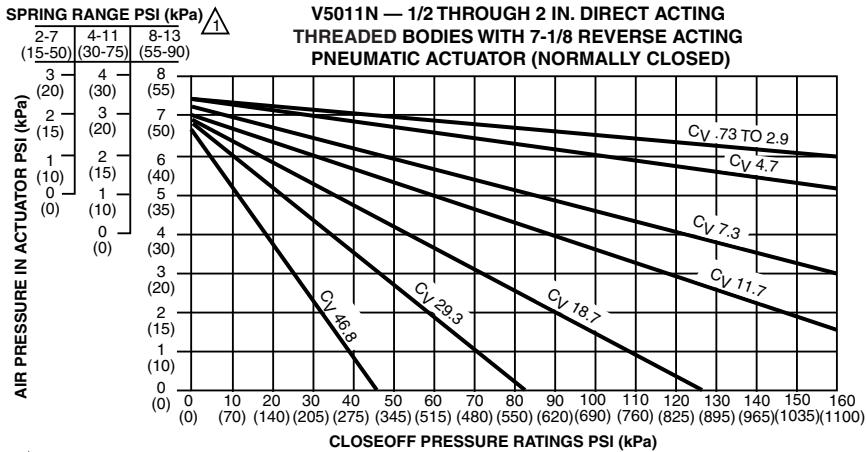

△ USE 4-11 PSI SPRING FOR POSITIONER MODEL (MP953E). M16051

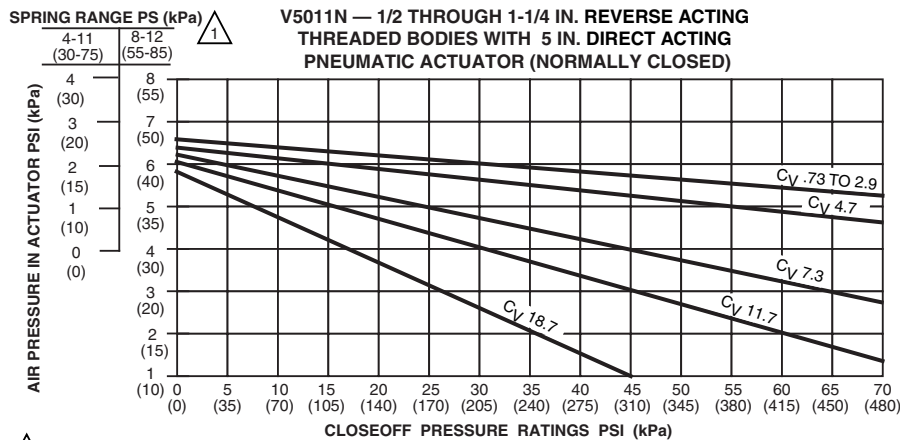

△ USE 4-11 PSI SPRING FOR POSITIONER MODEL (MP953E). M16052

Fig. 3. Close-off ratings at various control air pressures for V5011N Valves and MP953 Pneumatic Actuators. (continued)

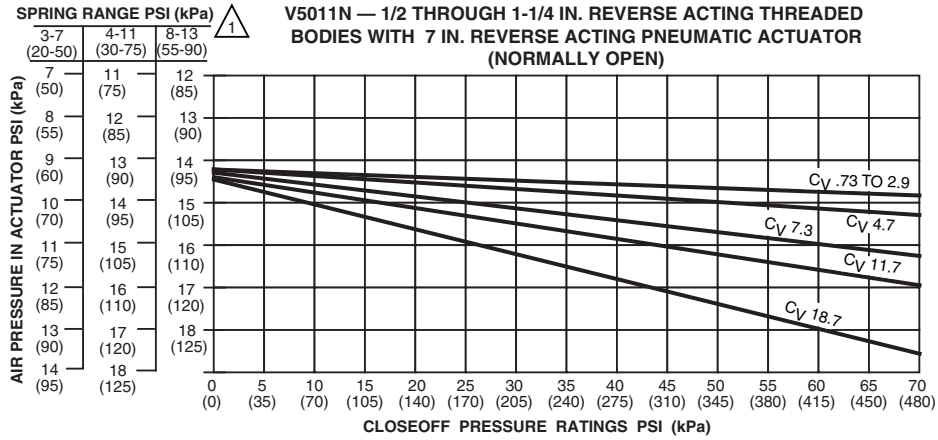

1 USE 4-11 PSI SPRING FOR POSITIONER MODEL (MP953E).

M16054

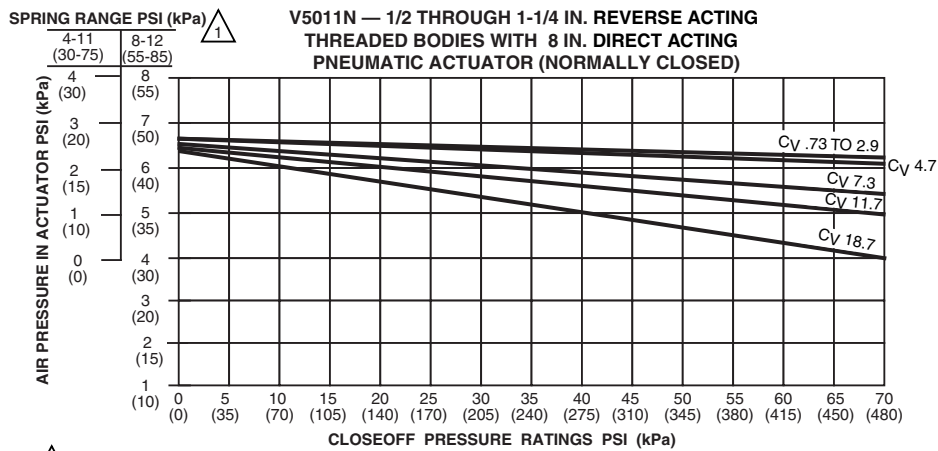

1 USE 4-11 PSI SPRING FOR POSITIONER MODEL (MP953E).

M16053

Fig. 3. Close-off ratings at various control air pressures for V5011N Valves and MP953 Pneumatic Actuators. (continued)

INSTALLATION

When Installing This Product...

1. Read these instructions carefully. Failure to follow them could damage the product or cause a hazardous condition.
2. Check the ratings given in the instructions and on the product to make sure the product is suitable for your application.
3. Installer must be a trained, experienced service technician.
4. After installation is complete, check out product operation as provided in these instructions.

IMPORTANT

1. Do not lift the valve by holding the stem.
2. Do not mount the valve with the stem pointed lower than horizontal.
3. Mount the valve with the flow arrow pointed in the direction of flow through the valve.
4. Mount the valve between aligned pipes. Mounting the valve on pipes that are not aligned causes leakage at the valve-to-pipe connection.

5. Ensure complete engagement on pipe to valve body threads.
6. Hold the valve body with a clamp or pipe wrench on the hexagonal fitting nearest the pipe to prevent damage to the valve body while mounting on the pipe. Refer to Fig. 4.
7. Be sure to allow enough room for installation and service. Clearance for valve installation is dependent on actuator size and the valve pipe size.

Location

Select a location where the valve, linkage, and actuator are within the appropriate pressure and temperature ratings.

Leave sufficient clearance above the valve to accommodate actuator installation and allow room for servicing the valve body. (Completely install the valve body in the pipe line before installing the actuator and linkage.)

When selecting a location for the valve, consider actuator mounting restrictions. Modutrol IV™ Motor crankshafts must be mounted horizontally.

Mounting

The preferred valve mounting position is with the stem vertical. For steam applications, mount with the stem at a 45 degree angle. Do not mount the valve with the stem more than 90 degrees from the vertical (pointing lower than horizontal). Scale and foreign material can collect, scoring the stem and causing packing leakage. Protect the stem from damage due to bending or scratching.

IMPORTANT

1. Before installing linkage and actuator, make sure that the valve stem operates freely. Impaired stem operation can indicate that the body was twisted or the stem was bent. Either of these conditions can require valve replacement.
2. Align pipes squarely with valve at each end connection.

3. If the pipes are forced into the valve, the body can become twisted and improper seating can result.
4. Apply pipe dope sparingly.
5. Be careful to prevent pipe debris, such as chips and scale, from entering the piping because this material can lodge in the seat and prevent proper closing.

NOTE: Threading on threaded bodies conform to NPT.

Refer to the table in Fig. 4 for valve pipe sizes and thread lengths. Fig. 4 also shows two effective methods of holding the valve and pipe when attaching it. Refer to installation information furnished with the linkage and motor when installing these controls.

Table 2. Close-off Ratings (psid) for V5011N Valves with Electric/Electronic Actuators.

Valve Size (NPT)	Mod IV Motor with Q5001 Linkages			ML6421A, ML7421A	ML6425, ML7425 ML6420, ML7420	ML7984, ML6874
	320 lb	160 lb	80 lb	405 lb	135 lb	160 lb
V5011N1xxx and V5011N3xxx Valves						
1/2	—	230 ^a	230 ^a	—	230 ^a	230 ^a
3/4	—	230 ^a	131			
1	230 ^a	196	91	230 ^a	163	196
1-1/4	230 ^a	126	57	230 ^a	104	126
1-1/2	173	81	36	221	67	81
2	98	46	19	126	37	46
V5011N2xxx Valves						
1/2, 3/4	—	100 ^a	100 ^a	—	100 ^a	100 ^a
1	100 ^a	100 ^a	91			
1-1/4	100 ^a	100 ^a	57			
1-1/2	100 ^a	81	36	100 ^a	67	81
2	98	46	19	100 ^a	37	46

^aPressure is limited by fluid temperature. See valve temperature/pressure ratings.

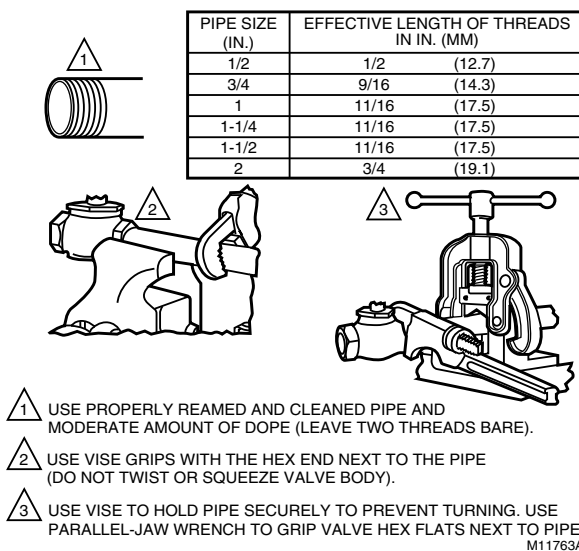

Fig. 4. Installing valves with threaded connections.

CHECKOUT

Use the following procedure to check for proper valve operation:

1. Check valve body and connections for leaks.

IMPORTANT

Before installing linkage (if used) and actuator, make sure that the valve stem operates freely. Impaired stem operation can indicate that the body was twisted or the stem was bent. Either of these conditions can require valve replacement.

2. After installing linkage and actuator, check operation according to installation information furnished with these controls.

3. Operate system through one complete cycle to ensure valve controls properly.
4. Check valve at regular intervals for leakage around packing.

NOTE: Packing is spring-loaded and should seldom require attention.

5. If leakage is discovered and inspection shows that the packing gland is screwed down tightly, then repack the valve.

Table 3. Valve Rebuild and Repack Kits.

Valve OS No.	NPT Size (in.)	Flow Capacity (C _v)	Stem Diameter (in.)	Repack Kit	Rebuild Kit	Stem Button	
V5011N1008	1/2	0.73	1/4	0901786A	0901746A	0901116A ^a	
V5011N1016		1.16			0901747A		
V5011N1024		1.85			0901748A		
V5011N1032		2.9			0901749A		
V5011N1040		4.7			0901750A		
V5011N1057	3/4	7.3	3/8	0901787A	0901751A		
V5011N1065	1	11.7			0901752A		
V5011N1073	1-1/4	18.7			0901753A		
V5011N1081	1-1/2	29.3			0901754A		
V5011N1099	2	46.8			0901755A		
V5011N2006	1/2	0.73	1/4	0901786A	0903422A		
V5011N2014		1.16			0903423A		
V5011N2022		1.85			0903424A		
V5011N2030		2.9			0903425A		
V5011N2048		4.7			0903426A		
V5011N2055	3/4	7.3	3/8	0901787A	0903427A		
V5011N2063	1	11.7			0903428A		
V5011N2071	1-1/4	18.7			0903429A		
V5011N2089	1-1/2	29.3			0903430A		
V5011N2097	2	46.8			0903431A		
V5011N3004	1/2	2.9	1/4	0901786A	0901759A		
V5011N3012		4.7			0901760A		
V5011N3020	3/4	7.3	1/4	0901786A	0901761A		
V5011N3038	1	11.7			0901762A		
V5011N3046	1-1/4	18.7			1/4	0901786A	0901763A

^aEach 0901116A contains 10 stem buttons.

NOTE: Seat removal tools are required to rebuild valves:
32003941-001 for 1/2 in. through 1-1/4 in. sizes.
32003941-002 for 1-1/2 in. through 2 in. sizes.

V5011N TWO-WAY THREADED GLOBE VALVE

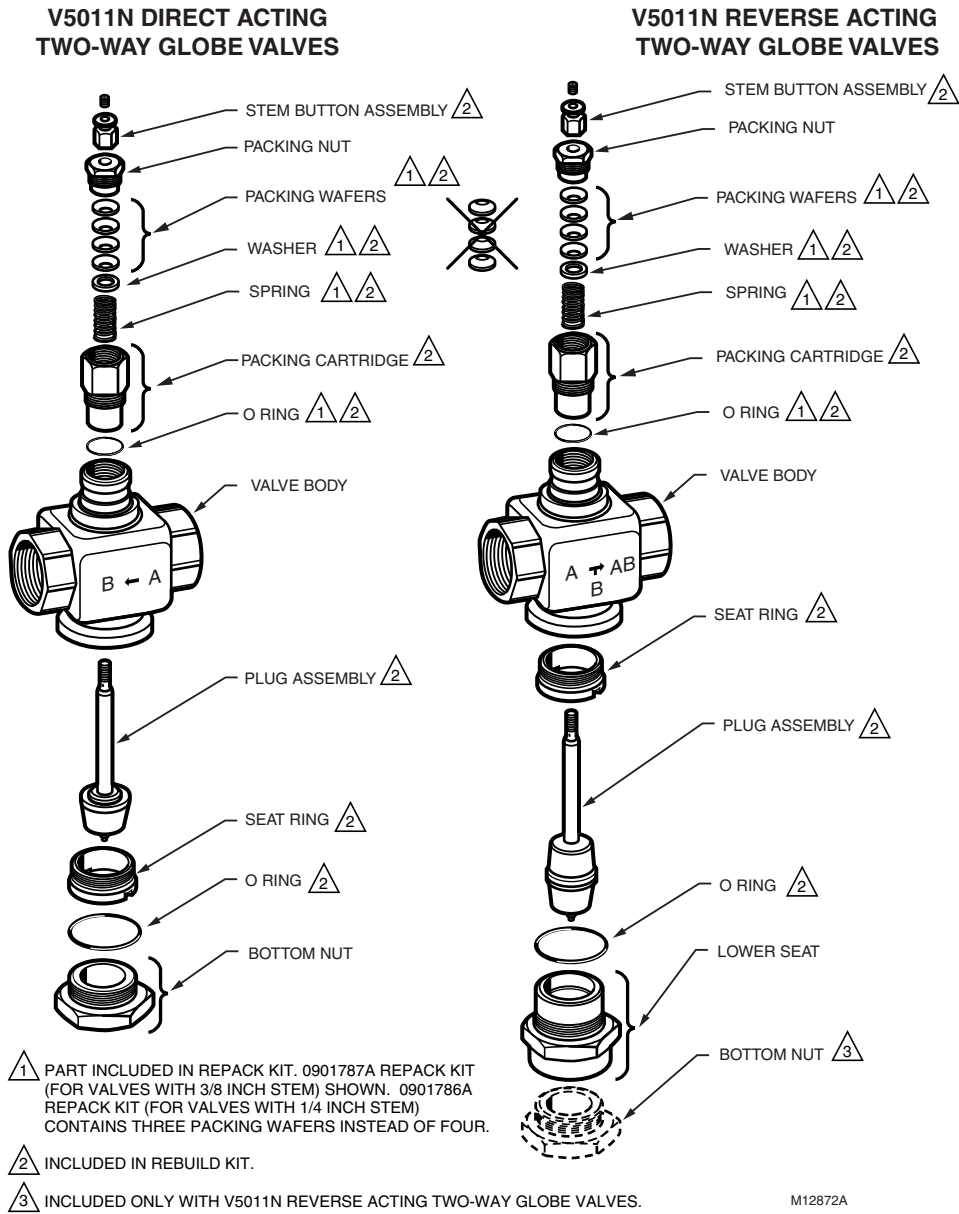

Fig. 5. V5011N replacement parts.

By using this Honeywell literature, you agree that Honeywell will have no liability for any damages arising out of your use or modification to, the literature. You will defend and indemnify Honeywell, its affiliates and subsidiaries, from and against any liability, cost, or damages, including attorneys' fees, arising out of, or resulting from, any modification to the literature by you.

Automation and Control Solutions

Honeywell International Inc.
 1985 Douglas Drive North
 Golden Valley, MN 55422
 customer.honeywell.com



® U.S. Registered Trademark
 © 2016 Honeywell International Inc.
 63-2548-04 M.S. Rev. 08-16
 Printed in United States