

Compact Variable Frequency Drive

Honeywell



Installation Guide



62-0269-02

**Honeywell Technical Support
888-516-9347**

**Honeywell Customer Web-site:
customer.honeywell.com**

**VFD technical data can be accessed via:
customer.honeywell.com/VFD**

GENERAL

This installation guide explains the steps necessary for installation and setup of the Honeywell Compact VFD. Before commissioning the drive, download and read the complete Honeywell Compact VFD manual at: customer.honeywell.com/VFD

SAFETY

WARNING

Only a competent electrician is allowed to carry out the electrical installation!

This installation guide contains clearly marked warnings which are intended for your personal safety and to avoid unintentional damaged to the product or connected appliances.

Please read these warnings carefully:

WARNING

The components of the power unit of the frequency converter are live when the VFD is connected to mains potential. Coming into contact with this voltage is extremely dangerous and may cause death or severe injury. The control unit is isolated from the mains potential.

WARNING

The motor terminals U, V, W (T1, T2, T3) and the possible brake resistor terminals -/+ are live when the VFD is connected to mains, even if the motor is not running.

WARNING

The control I/O-terminals are isolated from the mains potential. However, the relay output terminals may have a dangerous control voltage present even when Honeywell Compact is disconnected from mains.

WARNING

The earth leakage current of the VFD exceeds 3.5 mA AC. According to standard EN61800-5-1, a reinforced protective ground connection must be ensured.

WARNING

If the VFD is used as a part of a machine, the machine manufacturer is responsible for providing the machine with a main switch (EN 60204-1).

WARNING

If the VFD is disconnected from mains while running the motor, it remains live if the motor is energized by the process. In this case the motor functions as a generator feeding energy to the frequency converter.

COMPACT VARIABLE FREQUENCY DRIVE

Dimensions and weight	Frame	H in (mm) W in (mm) D in (mm)	Weight lb (kg)
	MI1	6.2 (156.5) 2.6 (66.0) 3.9 (99.0)	1.2 (0.55)
	MI2	7.7 (195) 3.5 (90) 4.0 (101.5)	1.5 (0.70)
	MI3	9.9 (195) 3.9 (100) 4.3 (108.5)	2.2 (0.99)
Motor connection	Output voltage	0 - U _{in}	
	Output current	Continuous rated current I _N at ambient temperature max. 122° F (50° C), overload 1.5 x I _N max. 1min/10min	
Ambient conditions	Ambient operating	122° F - (10° C) (no frost)...122° F (50° C): rated loadability I _N	
	Storage temperature	-40° F (-40° C)... 158° F (70° C)	
	Enclosure class	IP20	
	Relative humidity	0...95% RH, non-condensing, non-corrosive, no dripping water	
	Altitude	100% load capacity (no derating) up to 3,280 ft. (1000 m). 1% derating for each 328 ft. (100 m) above 3,280 ft. (1000 m); max. 6,560 ft (2000 m).	
EMC	Immunity	Complies with EN50082-1, -2, EN61800-3	
	Emissions	230V: Complies with EMC category C2 (Honeywell level H); With an internal RFI filter 400V: Complies with EMC category C2 (Honeywell level H); With an internal RFI filter Both: No EMC emission protection (Honeywell Compact level N); Without RFI filter See detailed descriptions in Honeywell Compact User Manual at: customer.honeywell.com/VFD	
Standards		For EMC: EN61800-3, For safety: UL508C, EN61800-5	
Certificates and manufacturer's declarations of conformity		For safety: CB, CE, UL, cUL, For EMC: CE, CB, c-tick (see unit nameplate for more detailed approvals)	

Cable and fuse requirements	Frame	Fuse (A)	Mains cable Cu (mm ²)	Terminal cable min-max (mm ²)	
				Main & earth	Control & relay
380 500 V	MI1	6	3*1.5+1.5	1.5-4	0.5-1.5
	MI2	10			
	MI3	20			
208 - 240V	MI1	10	2*1.5+1.5	1.5-4	
	MI2	20			
	MI3	32			

- Use cables with heat resistance of at least 158° F (70° C).
- The fuses function also as cable overload protection.
- These instructions apply only to cases with one motor and cable connection from the frequency converter to the motor.

Honeywell Compact Power Ratings

Mains voltage 208-240 V, 50/60 Hz, 1~ In, 3~ Out					
Frequency converter type	Rated loadability		Motor shaft power	Nominal input current	Mechanical size
	100% continuous current I_N [A]	150% over-load current [A]	208-240V supply P [Hp]	[A]	
HVFDCD1B0003xxx	1.7	2.6	0.25	4.2	MI1
HVFDCD1B0005xxx	2.4	3.6	0.5	5.7	MI1
HVFDCD1B0007xxx	2.8	4.2	0.75	6.6	MI1
HVFDCD1B0010xxx	3.7	5.6	1	8.3	MI1
HVFDCD1B0015xxx	4.8	7.2	1.5	11.2	MI2
HVFDCD1B0020xxx	7.0	10.5	2	14.1	MI2
HVFDCD1B0030xxx	11.0	16.5	3	22.8	MI3

Mains voltage 380-480 V, 50/60 Hz, 3~ In, 3~ Out					
Frequency converter type	Rated loadability		Motor shaft power	Nominal input current	Mechanical size
	100% continuous current I_N [A]	150% over-load current [A]	380-480V supply P [Hp]	[A]	
HVFDCD3C0005xxx	1.3	2.0	0.5	2.2	MI1
HVFDCD3C0007xxx	1.9	2.9	0.75	2.8	MI1
HVFDCD3C0010xxx	2.4	3.6	1	3.2	MI1
HVFDCD3C0015xxx	3.3	5.0	1.5	4.0	MI1
HVFDCD3C0020xxx	4.3	6.5	2	5.6	MI2
HVFDCD3C0030xxx	5.6	8.4	3	7.3	MI2
HVFDCD3C0040xxx	7.6	11.4	4	9.6	MI3
HVFDCD3C0050xxx	9.0	13.5	5	11.5	MI3
HVFDCD3C0075xxx	12.0	18.0	7.5	14.9	MI3

NOTE: The input currents are calculated values with 100 kVA line transformer supply.

INSTALLATION

Mechanical Installation

These are two possible ways to mount the VFD to the wall; either screw or DIN-rail mounting.

MI1

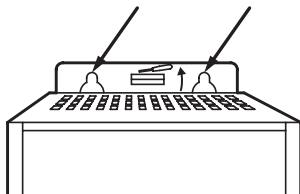

MI2-3

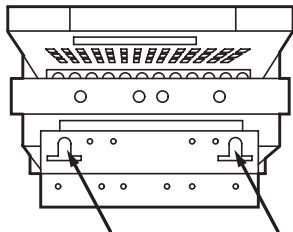
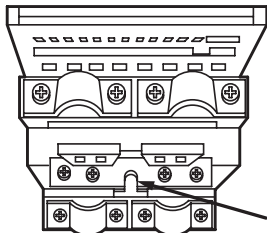
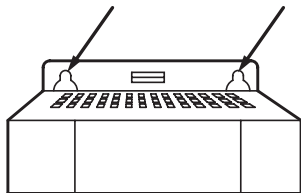

M25473

Fig. 1. Screw Mounting

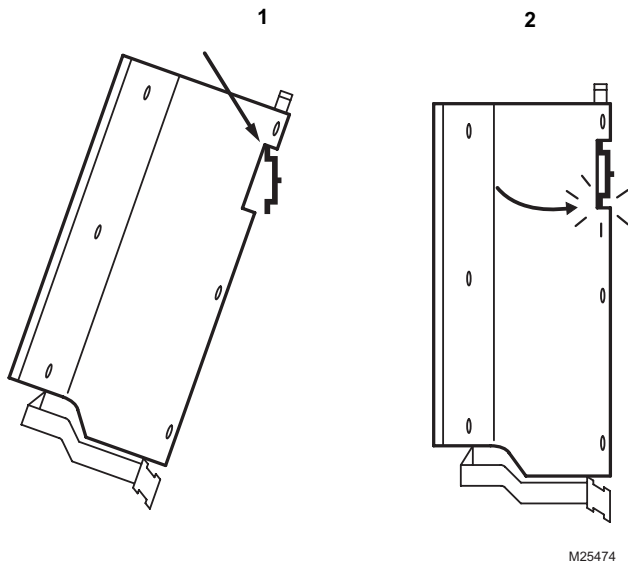

Fig. 2. DIN-rail Mounting

NOTE: See the mounting dimensions on the back of the drive. Leave free space for cooling above 4 in. (102 mm) and below 2 in. (51 mm).

Cabling and Connections

Power Cabling

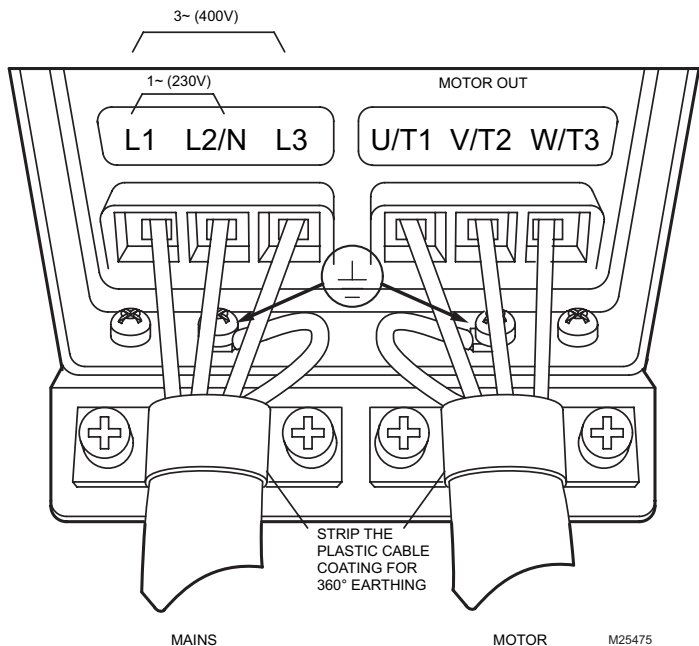

Fig. 3. Power Connections, Frame Size MI1

COMPACT VARIABLE FREQUENCY DRIVE

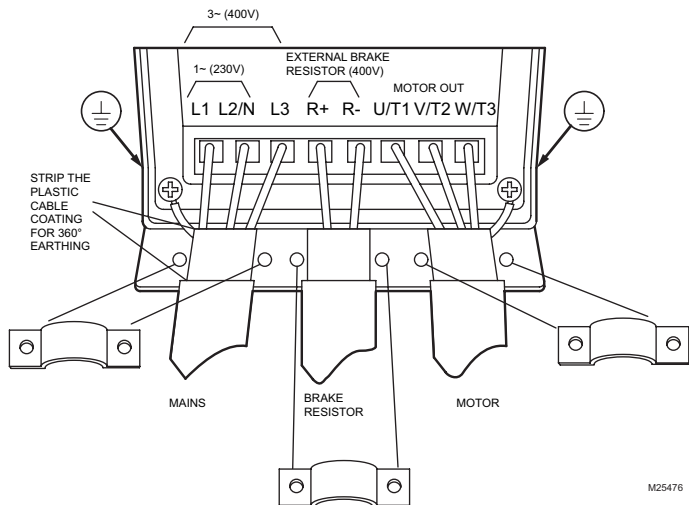

Fig. 4. Power Connections, Frame Size MI2 - MI3

Control Cabling

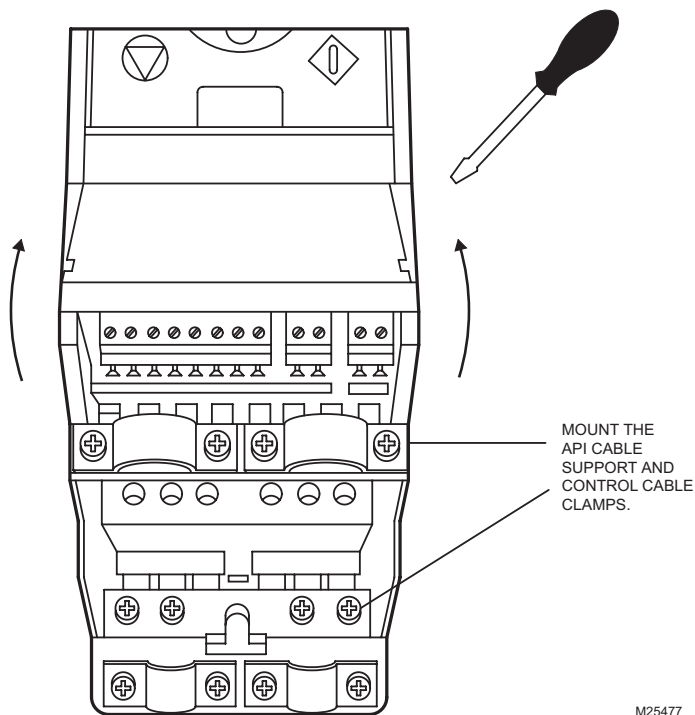
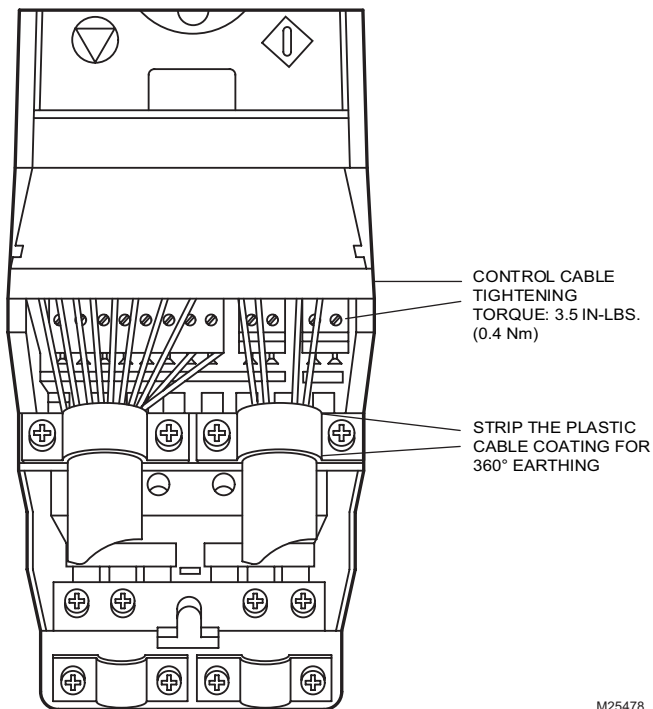

Fig. 5. Open Cover



SEE USER MANUAL

Fig. 6. Install the Control Cables

CONTROL I/O

Table 1. Default I/O Configuration and Corrections

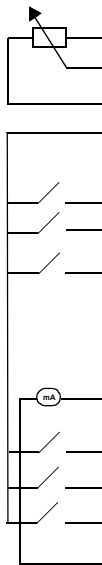

Terminal	Signal	Factory Preset	Description
1	+10Vre	Ref voltage out	Maximum load 10 mA
2	All	Analog signal in 1	Freq. reference ^{P)} 0- +10 V Ri = 200 k Ω (min)
3	GND	I/O signal ground	
6	24Vout	24V output for DI's	± 20%, max. load 50 mA
7	GND	I/O signal ground	
8	D11	Digital input 1	1 = Start forward 0 - +30 V Ri = 12 Ω min
9	D12	Digital input 2	2 = Start reverse ^{P)}
10	D13	Digital input 3	3 = Speed select 1 ^{P)}
A	A	RS485 signal A	FB Communication
B	B	RS485 signal B	FB Communication
4	A12	Analog signal in 2	PI actual value ^{P)} 0(4) - 20 mA, RL = 200Ω
5	GND	I/O signal ground	
13	GND	I/O signal ground	
14	D14	Digital input 4	Preset speed B0 ^{P)} 0 - +30 V Ri = 12 Ω min
15	D15	Digital input 5	Preset speed B1 ^{P)}
16	D16	Digital input 6	Preset speed B2 ^{P)}
18	AO		Output frequency ^{P)} 0(4) - 20 mA, RL = 500Ω
20	DO	Digital signal out	Open collector, max. load 48 V/50mA
21	RO 11	Relay out 1	Active = Fault ^{P)} Max. switching load: 250 Vac/2A or 250 Vdc/0,4A
22	RO 12		
23	RO 13		
25	RO 21	Relay out 2	Active = RUN ^{P)} Max. switching load: 250 Vac/2A or 250 Vdc/0,4A
26	RO 22		

^{P)} = Programmable function, see User manual, Parameters

SETUP & NAVIGATION

Main Menu

REFERENCE MENU
DISPLAYS THE REFERENCE VALUE REGARDLESS OF THE SELECTED CONTROL PLACE.



MONITORING MENU
IN THIS MENU YOU CAN BROWSE THE MONITORING VALUES.

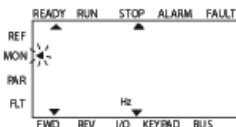

PARAMETER MENU
IN THIS MENU YOU CAN BROWSE AND EDIT THE PARAMETERS.

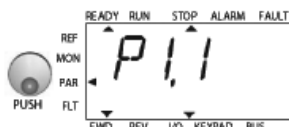
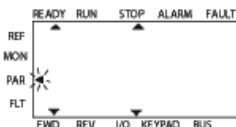

FAULT MENU
HERE YOU WILL BE ABLE TO BROWSE THROUGH THE FAULTS OCCURRED.

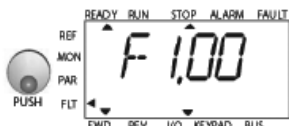
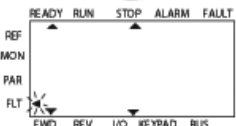

V23471

Fig. 7. Main Menu

Commissioning and Startup Wizard

Table 2. Commissioning Steps:

1. Read safety instructions on page 1	6. Run the Startup wizard and set all necessary parameters
2. Secure the grounding and check that cables comply with requirements	7. Perform test run without motor, see the User Manual at customer.honeywell.com/VFD
3. Check quality and quantity of cooling air	8. Run no-load tests without motor being connected to the process
4. Check that all start/stop switches are in STOP position	9. Connect the motor to the process and perform test run once again
5. Connect the drive to mains	10. customer.honeywell.com/VFD is now ready for use

Startup Wizard

Honeywell Compact runs the startup wizard in first power-up. After that the wizard can be run by pressing STOP for 5 seconds in main menu. The following figures show the procedure.

NOTE: Running the startup wizard will always return all parameter settings to their factory defaults!

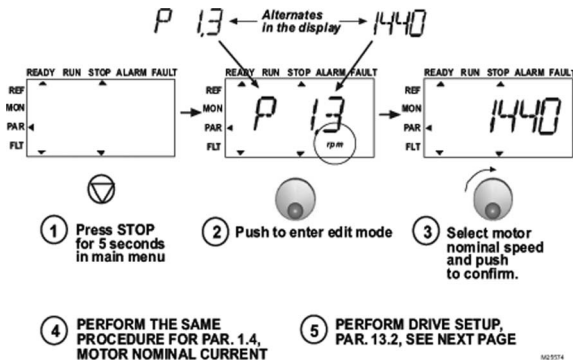

Fig. 8. Honeywell Compact Startup Wizard

COMPACT VARIABLE FREQUENCY DRIVE



Selections:

	P1.1	P1.2	P1.7	P1.15	P2.1	P2.2	P2.3	P3.1	P3.2	P3.3	P4.2	P4.3
0 = Basic	400 V*	50 Hz	1,1 * INMOT	0= Not used	I/O	0= Ramp	0= Coast.	0 Hz	50 Hz	0= All 0-10V	3 s	3 s
1 = Pump drive	400 V*	50 Hz	1,1 * INMOT	0= Not used	I/O	0= Ramp	1= Ramp	20 Hz	50 Hz	0= All 0-10V	5 s	5 s
2 = Fan drive	400 V*	50 Hz	1,1 * INMOT	0= Not used	I/O	0= Ramp	0= Coast.	20 Hz	50 Hz	0= All 0-10V	20 s	20 s
3 = Conveyor drive	400 V*	50 Hz	1,5 * INMOT	1= Used	I/O	0= Ramp	0= Coast.	0 Hz	50 Hz	0= All 0-10V	1 s	1 s

*In drives of 208V...230V this value is 230V

Parameters affected:

P1.1 Motor Un (V)
 P1.2 Motor fn (Hz)
 P1.7 Current limit (A)
 P1.15 Torque boost
 P2.1 Control place
 P2.2 Start function

P2.3 Stop function
 P3.1 Min frequency
 P3.2 Max frequency
 P3.3 I/O reference
 P4.2 Acc. time (s)
 P4.3 Dec time (s)

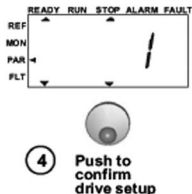

W2075

Fig. 9. Drive Setup

Quick Setup

Follow these steps to select between four different applications: Basic, Pump drive, Fan drive, and Conveyor drive.



SELECTIONS:

	P1.1	P1.2	P1.3	P1.4	P1.5	P1.6	P1.7	P1.11	P1.12	P1.13	P1.14	P6.2
0 = Basic	0 Hz	60 Hz	3 s	3 s	1.5	400 V*	60 Hz	0= Ramp	0= Coast.	I/O	0= A1 0-10V	0= Not used.
1 = Pump drive	20 Hz	60 Hz	5 s	5 s	1.1	400 V*	60 Hz	0= Ramp	1= Ramp	I/O	0= A1 0-10V	0= Not used.
2 = Fan drive	20 Hz	60 Hz	20 s	20 s	1.1	400 V*	60 Hz	0= Ramp	0= Coast.	I/O	0= A1 0-10V	0= Not used.
3 = Conveyor drive	0 Hz	60 Hz	1 s	1 s	1.8	400 V*	60 Hz	0= Ramp	0= Coast.	I/O	0= A1 0-10V	1= Used

*In drives of 208V, 230V this value is 230V

PARAMETERS AFFECTED:

P1.1 Min frequency
 P1.2 Max frequency
 P1.3 Acc. time (s)
 P1.4 Dec. time (s)
 P1.5 Current limit (A)
 P1.6 Motor Un (V)

P1.7 Motor fn (Hz)
 P1.11 Start function
 P1.12 Stop function
 P1.13 Control place
 P1.14 I/O references
 P6.2 Torque boost



525483

Fig. 10. Quick Setup

MONITORING & PARAMETERS

Monitoring Values

Table 3. Monitoring Values

Code	Parameters	Unit	Description
M1.1	Output frequency	Hz	Frequency to the motor
M1.2	Frequency reference	Hz	
M1.3	Motor shaft speed	rpm	Calculated motor speed
M1.4	Motor current	A	Measured motor current
M1.5	Motor torque	%	Calculated actual/nominal torque of the motor
M1.6	Motor power	%	Calculated actual/nominal power of the motor
M1.7	motor voltage	V	Calculated motor voltage
M1.8	DC-link voltage	V	Measured DC-link voltage
M1.9	Unit temperature	C °	IGBT Temperature
M1.10	Motor temperature	C °	Calculated motor temperature
M1.10	Analogue input 1	%	AI1 value
M1.11	Analogue input 2	%	AI2 value
M1.12	Analogue output current	%	AO1
M1.13	DI1, DI2, DI3,		Digital input statuses
M1.14	DI3, DI4, DI6		Digital input statuses
M1.15	RO1, RO2, DO		Relay/digital output statuses
M1.16	PI reference	%	In percent of the maximum process reference
M1.17	PI actual value	%	In percent of the maximum actual value
M1.18	PI error value	%	In percent of the maximum error value
M1.19	PI Output	%	In percent of the maximum output value

Basic Parameters

Table 4. Quick Setup Parameters

Code	Parameter	Min	Max	Unit	Default	ID	Note
P1.1	Motor nominal voltage	180	500	V	230 400	110	Check rating plate on the motor
P1.2	Motor nominal frequency	30	320	Hz	50.00	111	Check rating plate on the motor
P1.3	Motor nominal speed	300	20000	rpm	1440	112	Default applies for a 4-pole motor.
P1.4	Motor nominal current	0.2 - I _{Nunit}	1.5 x I _{Nunit}	A	I _{Nunit}	113	Check rating plate on the motor
P1.5	Motor cos Φ	0.30	1.00		0.85	120	Check rating plate on the motor
P1.7	Current Limit	0.2 x I _{Nunit}	2 x I _{Nunit}	A	1.5 x I _{Nunit}	107	
P1.15	Torque boost	0	1		0	109	0 = Not used 1 = Used
P2.1	Control place	1	3		1	125	1 = I/O terminal 2 = Keypad 3 = Fieldbus
P2.2	Start function	0	1		0	505	0 = Ramp 1 = Flying start
P2.3	Start function	0	1		0	506	0 = Coasting 1 = Ramp
P3.1	Min frequency	0.00	P3.2	Hz	0.00	101	
P3.2	Max frequency	P3.1	320	Hz	50.00	102	
P3.3	I/O reference	0	4		3	117	0 = Preset Speeds (0-7) 1 = Keypad Reference 2 = Fieldbus Reference 3 = AI1 (API LIMITED & FULL) 4 = AI2 (API FULL)
P3.4	Preset speed 0	0.00	P3.2	Hz	5.00	124	Activated by digital inputs
P3.5	Preset speed 1	0.00	P3.2	Hz	10.00	105	Activated by digital inputs
P3.6	Preset speed 2	0.00	P3.2	Hz	15.00	106	Activated by digital inputs
P3.7	Preset speed 3	0.00	P3.2	Hz	20.00	126	Activated by digital inputs
P4.2	Acceleration time	0.1	3000	s	1.0	103	

Table 4. Quick Setup Parameters (Continued)

Code	Parameter	Min	Max	Unit	Default	ID	Note
P4.3	Deceleration time	0.1	3000	s	1.0	104	
P6.1	AI1 Signal range	0	3		0	379	0 = Voltage 0...10 V (F + L) 1 = Voltage 2...10 V (F + L) 2 = Current 0...20 mA (L) 3 = Current 4...20 mA (L)
P6.5	AI2 Signal range (API FULL)	2	3		3	390	2 = Current 0...20 mA 3 = Current 4...20 mA
P10.4	Automatic restart	0	1		0	731	0 = Not used 1 = Used
p13.1	Parameter conceal						0 = All parameters visible 1 = Only basic parameters

Table 5. System Menu Parameters

Code	Parameter	Min	Max	Default	Note
Software information (MENU PAR -> S1)					
S1.1	Software package				
S1.2	Power SW version				
S1.3	API SW version				
S1.4	API Firmware interface				
S1.5	Application ID				
S1.6	Application revision				
S1.7	System load				
RS458 Information (MENU PAR -> S2)					
S2.1	Communication status				Format: xx.yyy xx =0 - 64 (Number of error messages) yyy = 0 - 999 (Number of good messages)
S2.2	Fieldbus protocol	0	1	0	0 =FB disabled 1 =Modbus
S2.3	Slave address	1	255		
S2.4	Baud rate	0	5	5	0 =300, 1 =600, 2 =1200, 3 =2400, 4 =4800, 5 =9600
S2.5	Number of stop bits	0	1	1	0 =1, 1 =2
S2.6	Parity type	0	0	0	0 =None (locked)
S2.7	Communication time-out	0	255	0	0 =Not used, 1 =1 second, 2 =2 seconds, etc.
S2.8	Reset communication status				1 =Resets par. S2.1
Total counters (MENU PAR -> S3)					
	MWh counter	0	1	0	
	Power on days	0	1	0	
	Power on hours	0	1	0	
User settings (MENU PAR -> S4)					
	Display contrast				Adjusts the display contrast
	Restore factory defaults				1 =Restores factory defaults

FAULT TRACING

Table 6. Fault Codes

Fault Code	Fault Name
1	Overcurrent
2	Overvoltage
3	Earth fault
8	System fault
9	Undervoltage
13	Frequency converter undertemperature
14	Frequency converter overtemperature
15	Motor stalled
16	Motor overtemperature
22	EEPROM Checksum fault
25	Microcontroller watchdog fault
34	Internal bus communication
35	Application fault
50	Analogue input $I_{in} < 4$ mA (selected signal range 4 to 20 mA)
51	External fault
53	Fieldbus fault

By using this Honeywell literature, you agree that Honeywell will have no liability for any damages arising out of your use or modification to, the literature. You will defend and indemnify Honeywell, its affiliates and subsidiaries, from and against any liability, cost, or damages, including attorneys' fees, arising out of, or resulting from, any modification to the literature by you.

Automation and Control Solutions

Honeywell International Inc.
1985 Douglas Drive North
Golden Valley, MN 55422
customer.honeywell.com

Honeywell Limited-Honeywell Limitée
35 Dynamic Drive
Toronto, Ontario M1V 4Z9



Printed in U.S.A. on recycled paper containing at least 10% post-consumer paper fibers.

® U.S. Registered Trademark
© 2008 Honeywell International Inc.
62-0269—02 J.I. Rev. 09-08

Honeywell