

P7650A/B/U

DIFFERENTIAL PRESSURE TRANSDUCER, DRY MEDIA

INSTALLATION INSTRUCTIONS



Universal models can be configured for duct or panel and for 0 to 1 in. (0 to 250 Pa) or 0 to 10 in. (0 to 2500 Pa) pressure ranges. All variants are available with and without LCD display. The P7650A/B/U has an IP65/NEMA 4 environmental rating and a 5-year limited warranty.

IMPORTANT

- This product is not intended for life or safety applications.
- Do not install this product in hazardous or classified locations.
- Read and understand the instructions before installing this product.
- Turn off all power supplying equipment before working on it.
- The installer is responsible for conformance to all applicable codes.
- If this product is used in a manner not specified by the manufacturer, the protection provided by the product may be impaired. No responsibility is assumed by the manufacturer for any consequences arising out of the use of this material.

APPLICATION

The P7650A/B/U Differential Pressure Sensor measures static and differential air pressure in duct and panel applications. It can also measure air velocity using pressure-velocity pick up tubes P7650L6, P7650L8, P7650L10, P7650L12, or P7650L14. P7650A/B/U can be ordered in duct or panel versions and in 0 to 1 in. (0 to 250 Pa) or 0 to 10 in. (0 to 2500 Pa) pressure ranges.

PRODUCT IDENTIFICATION

New Part Number	Mounting	Selectable w.c. Pressure Range, Uni or Bi-Directional	Velocity Mode	Display	Output	Supply Voltage
P7650A1000	Panel	+/-0-1", 0-25", 0-5", 0-1" w.c. or +/-25, 50, 100, 250 Pa Selectable	500/1,000/2,000/3,000 FPM	Yes	0-10Vdc, 0-5Vdc, and 4-20mA Selectable	12-30Vdc or 24Vac
P7650A1018			2.5/5/10/15MS	No		
P7650A1026			3,000/4,000/5,000/6,000 FPM	Yes		
P7650A1034			15/20/25/30MS	No		
P7650B1008	Duct	+/-0-1", 0-25", 0-5", 0-1" w.c. or +/-25, 50, 100, 250 Pa Selectable	500/1,000/2,000/3,000 FPM	Yes		
P7650B1016			2.5/5/10/15MS	No		
P7650B1024			3,000/4,000/5,000/6,000 FPM	Yes		
P7650B1032			15/20/25/30MS	No		
P7650U1040	Universal	+/-0-1", 0-25", 0-5", 0-1", 0-2", 0-5", 0-10" in. w.c. or +/-0.25, 0.5, 1.0, 2.5 kPa; or +/-25, 50, 100, 250 Pa Selectable	500/1,000/2,000/3,000/4,000/5,000/6,000/7,000 FPM	No		
P7650U1052			2.5/5/10/15/20/25/30/35 MS	Yes		



31-00138-03

DIMENSIONS

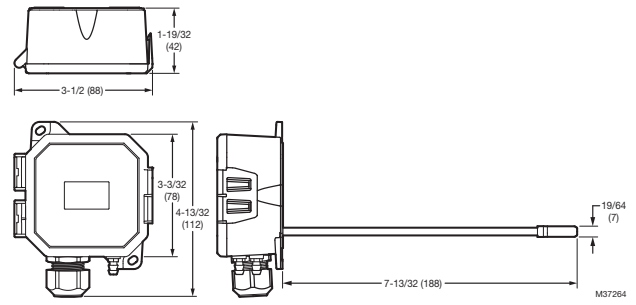

Fig. 1.

SPECIFICATIONS

Media Compatibility:
Dry air or inert gas

Input Power:
Three-wire Volt mode: 24 Vac or 12-30 Vdc*
Two-wire mA mode: 12-30 Vdc*

Output Power Field-selectable:
2-wire, loop-powered 4-20 mA**
(DC only, clipped and capped), 24 Vac/dc or 3-wire 0-5V/0-10V***

Response Time:
Standard: T95 in 20 sec, Fast: T95 in 2 sec, DIP switch selectable

Pressure Mode:
Selectable unidirectional or bidirectional (example: uni-directional 0 to 1 inch w.c., or bi-directional -1 to 1 inch w.c.), DIP switch selectable

Velocity Mode:
Velocity is set up in Feet/Minute or Meters/second

Display (Option):
Pressure mode: Signed 3-1/2 digit LCD, indicates pressure, overrange indicator
Velocity mode: Signed 4-1/2 digit LCD, indicates velocity, overrange indicator

Proof Pressure:
3 psid (20.6 kPa)

Burst Pressure:
5 psid (34.5 kPa)

Pressure Mode Accuracy:
±1% F.S. (combined linearity and hysteresis)

Velocity Mode Accuracy:
±90 FPM (±0.45 MS) plus 5% of measured value****

Temperature Effect:
1" (250 Pa) models: 0.05%/°C; 10" (2.5 kPa) models: 0.01%/°C
— (Relative to 25 °C) 0 to 50 °C (32 to 122 °F)

Zero Drift (1-year):
1" (250 Pa) models: 2.0% max.; 10" (2.5 kPa) models: 0.5% max.

Zero Adjust:
Pushbutton auto-zero and digital input (2-pos terminal block)

Operating Environment:
0 to 60 °C (32 to 140 °F)

Altitude of Operation:
0 to 3000 m

Pollution Degree:
2

Humidity Range:
100% RH, non-condensing

Mounting Location:
For indoor use only.

Fittings:
Brass barb; 0.24" (6.1 mm) o.d.

Limited Warranty:
5 years

Environmental Rating:
IP65, NEMA 4

Flammability Rating:
Plastic enclosure is UL 94 5VA fire retardant ABS

Accessories:
32003169-001 4 in. Duct Pressure Pick-up Probe. P7650L6, P7650L8, P7650L10, P7650L12, or P7650L14, Velocity Pick-up Probes. (Last number is probe length, i.e., P7650L6 has 6 inch probe, etc)

EMC Conformance: EN 61000-6-3:2007 and A1:2011 Class B, EN 61000-6-1:2007
* Class 2 power source.
** Minimum input voltage for 4 to 20 mA operation: 250 Ω loop = 12 Vdc; 500 Ω loop = 19 Vdc.
*** Minimum load resistance for Volt operation: 5 kΩ.
**** For measured values between 200 and 7000 FPM (1 and 35 MS).

INSTALLATION, WIRING & CONFIGURATION

- Plan the installation. Panel or duct mount?

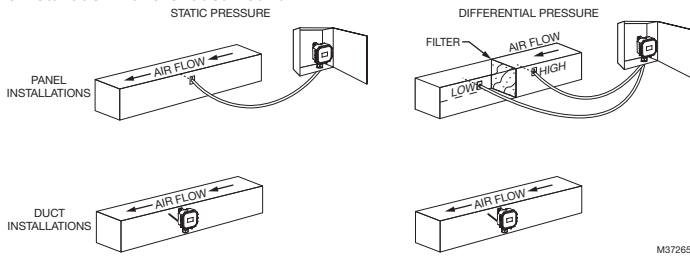

Fig. 2.

NOTE: Velocity measurement, shown below, requires the use of a pressure-velocity pick up tube, part P7650L6, P7650L8, P7650L10, P7650L12, or P7650L14. Length is the number after L in inches, so P7650L6 is 6 inch, etc. See form 31-00149 for details on installing and configuring the P7650L velocity pick up probes.

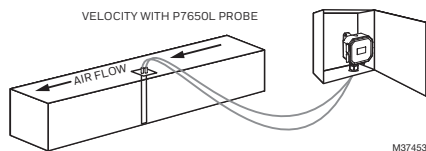

Fig. 3.

- For duct mount applications, thread the probe into the back of the device housing, as shown in the dimensional drawing.
- Configure the internal tubing for the selected installation method as described below.

Duct mount tubing configuration:

- Connect the right-side tube to the rear brass barb marked as "-" on the underside of the device housing.
- Connect the left-side tube to the probe in the back of the device housing.

Panel mount tubing configuration:

- Connect the right-side tube to the rear brass barb marked as "-" on the underside of the device housing.
- Connect the left-side tube to the front brass barb marked as "+" on the underside of the device housing.

- Mount the transducer (see the screw hole diagram below).

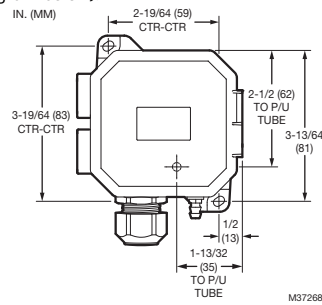

Fig. 5.

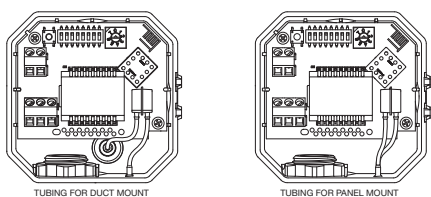

Fig. 4.

- For applications using conduit, remove the cable gland nut on the bottom of the unit. Thread a standard 1/2-inch NPT female threaded coupler onto the body of the cable gland. Connect the opposite end of the coupler to the conduit.

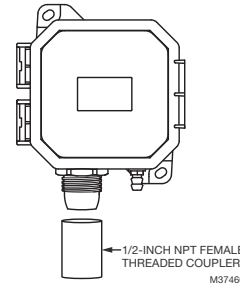

Fig. 6.

- Set DIP switches to desired settings.

Table 1.

DIP Switch	Setting
DIP Switch 1: Scale	ON = Pascal/MPS
	OFF = In. WC/FPM
DIP Switch 2: Mode	ON = Velocity
	OFF = Pressure
DIP Switch 3: Direction*	ON = Unidirectional
	OFF = Bidirectional
DIP Switch 4: Response	ON = Slow
	OFF = Fast
DIP Switch 5: Output	ON = 4-20 mA
	OFF = Voltage
DIP Switch 6: Volt Scale	ON = 0-5 Vdc
	OFF = 0-10 Vdc
DIP Switch 7	Unused
DIP Switch 8	Unused

*Velocity mode is unidirectional regardless of DIP switch setting.

Table 2. DIP Switch Settings.

	Scale	Mode	Direction	Response
ON	Pascal/MPS	Velocity	Uni	Slow
OFF	In. WC/FPM	Pressure	Bi	Fast
	1	2	3	4

	Output	Volt Scale	Unused	Unused
ON	mA	5V	Unused	Unused
OFF	Volt	10V	Unused	Unused
	5	6	7	8

- Set rotary switch to the desired setting. Align the arrow (not the slot) on the rotary switch to the desired full-scale range. LCD models momentarily indicate the selected range.

Rotary Switch Settings

Table 3. 0-1 Inch Range Models, Field Selectable (WC/FPM or Pa/MS).

	WC / FPM		Pa / MS
0	0 to 0.1 in. WC	0	0 to 25 Pa
1	0 to 0.25 in. WC	1	0 to 50 Pa
2	0 to 0.5 in. WC	2	0 to 100 Pa
3	0 to 1 in. WC	3	0 to 250 Pa
4	0 to 500 FPM	4	0 to 2.5 ms
5	0 to 1000 FPM	5	0 to 5 ms
6	0 to 2000 FPM	6	0 to 10 ms
7	0 to 3000 FPM	7	0 to 15 ms

Table 4. 0-10 Inch Range Models, Field Selectable (WC/FPM or Pa/MS).

	WC / FPM		Pa / MS
0	0 to 1 in. WC	0	0 to 250 Pa
1	0 to 2.5 in. WC	1	0 to 500 Pa
2	0 to 5 in. WC	2	0 to 1000 Pa
3	0 to 10 in. WC	3	0 to 2500 Pa
4	0 to 3000 FPM	4	0 to 15 ms
5	0 to 4000 FPM	5	0 to 20 ms
6	0 to 5000 FPM	6	0 to 25 ms
7	0 to 6000 FPM	7	0 to 30 ms

Table 5. P7640U Universal Model, Field Selectable (P) Pressure or (V) Velocity Mode, Field Selectable (WC/FPM or Pa/MS).

	(P) Pressure Mode		(V) Velocity Mode
0	0 to 0.1 in. WC (0 to 25 Pa)	0	0 to 500 FPM (0 to 2.5 MS)
1	0 to 0.25 in. WC (0 to 50 Pa)	1	0 to 1000 FPM (0 to 5 MS)
2	0 to 0.5 in. WC (0 to 100 Pa)	2	0 to 2000 FPM (0 to 10 MS)
3	0 to 1 in. WC (0 to 250 Pa)	3	0 to 3000 FPM (0 to 15 MS)
4	0 to 2.5 in. WC (0 to 500 Pa)	4	0 to 4000 FPM (0 to 20 MS)
5	0 to 5 in. WC (0 to 1000 Pa)	5	0 to 5000 FPM (0 to 25 MS)
6	0 to 10 in. WC (0 to 2500 Pa)	6	0 to 6000 FPM (0 to 30 MS)
7	0 to 10 in. WC (0 to 2500 Pa)	7	0 to 7000 FPM (0 to 35 MS)

- Connect the transmitter to the control system and power supply as indicated below. Optional: Connect the ZERO terminals to the digital output (contact closure) of the control system.

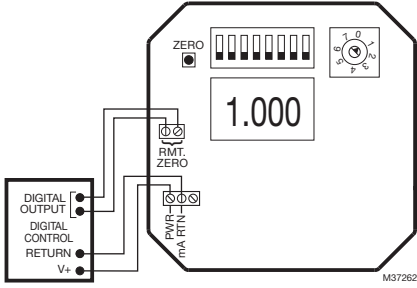

Fig. 7. 2-wire, 4-20 mA Current Loop Output.

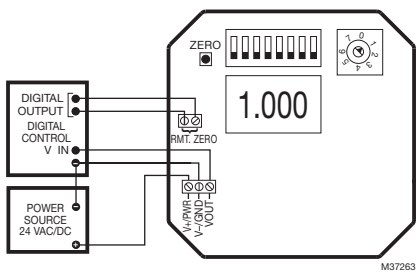

Fig. 8. 3-wire, 0-5 V/0-10 V Voltage Output.

- Wait five seconds, then press and hold the ZERO pushbutton for two seconds or provide contact closure on the AUX ZERO terminal. This will reset the output and display to zero pressure. For best accuracy, press the ZERO button while both ports are open to atmospheric pressure. To protect the unit from accidental zero, this feature is enabled only when the detected pressure is within about 0.1 in. WC (25 Pa) of factory calibration.
- Connect desired external tubing to the P7650A/B/U.

P7650A/B/U Series devices employ high performance sensors and sophisticated temperature compensation circuitry. The sensor achieves its best accuracy after an initial warm-up period. During the first few minutes of operation, readings at zero pressure and the lowest pressure ranges appear erroneous. Following this initial warm-up period, the P7650A/B/U device maintains its specified accuracy and stability.

The LCD momentarily indicates range 'SET' when a selection is made. Pressure is normally indicated on the display. Units are in inches water column (in. WC), Pascals (Pa) or kilopascals (kPa) as indicated on the display. The display shows 'OVER' when the pressure is over range.

CHINA ROHS COMPLIANCE INFORMATION ENVIRONMENT-FRIENDLY USE PERIOD (EFUP) TABLE

部件名称	有害物质 - Hazardous Substances					
	铅 (Pb)	汞 (Hg)	镉 (Cd)	六价铬 (Cr (VI))	多溴联苯 (PBB)	多溴二苯醚 (PBDE)
电子件 Electronic	X	0	0	0	0	0

本表格依据SJ/T11364的规定编制。

O: 表示该有害物质在该部件所有均质材料中的含量均在GB/T 26572规定的限量要求以下。
X: 表示该有害物质至少在该部件的某一均质材料中的含量超出GB/T 26572规定的限量要求。
(企业可在此处, 根据实际情况对上表中打 X 的技术原因进行进一步说明。)

This table is made according to SJ/T 11364.

O: Indicates that the concentration of hazardous substance in all of the homogeneous materials for this part is below the limit as stipulated in GB/T 26572.

X: Indicates that concentration of hazardous substance in at least one of the homogeneous materials used for this part is above the limit as stipulated in GB/T 26572.

REGULATORY INFORMATION

FCC REGULATIONS

§ 15.19 (a)(3)

This device complies with part 15 of the FCC Rules.

Operation is subject to the following two conditions:

- This device may not cause harmful interference, and
- This device must accept any interference received, including interference that may cause undesired operation.

Operation is subject to the following two conditions:

- This device may not cause interference; and
- This device must accept any interference, including interference that may cause undesired operation of the device.

Le présent appareil est conforme aux CNR d'Industrie Canada applicables aux appareils radio exempts de licence. L'exploitation est autorisée aux deux conditions suivantes :

- l'appareil ne doit pas produire de brouillage;
- l'utilisateur de l'appareil doit accepter tout brouillage radioélectrique subi, même si le brouillage est susceptible d'en compromettre le fonctionnement.

IC REGULATIONS

RSS-GEN

This device complies with Industry Canada's license-exempt RSSs.

FCC Warning (Part 15.21) (USA only)

Changes or modifications not expressly approved by the party responsible for compliance could void the user's authority to operate the equipment.

By using this Honeywell literature, you agree that Honeywell will have no liability for any damages arising out of your use or modification to, the literature. You will defend and indemnify Honeywell, its affiliates and subsidiaries, from and against any liability, cost, or damages, including attorneys' fees, arising out of, or resulting from, any modification to the literature by you.

Home and Building Technologies

In the U.S.:

Honeywell

715 Peachtree Street NE

Atlanta, GA 30308

customer.honeywell.com

Honeywell

* U.S. Registered Trademark
© 2018 Honeywell International Inc.
31-00138-03 M.S. Rev. 08-18
Printed in United States